

CDR Room CO₂ and Temperature Sensors (Controllers)

CDR sensors are designed to detect carbon dioxide concentration, and temperature in the room spaces. The CO₂ sensor calibrates automatically its measurement. The CDR sensors have linear 0..10V signals outputs relating to CO₂-concentration and temperature. The CDRC sensors have 2 x 4..20mA outputs.

The sensors can be used for demand controlled ventilation in buildings. CDR sensors can be installed on a wall surface or on a wall mounting box in dry indoor environment. The CDR sensors come with a number of options such as display, active/passive setpoint, digital output, occupancy detection, push buttons, lux level measurement and passive resistive sensor elements.

The CDR sensors can also operate as CO₂, Temperature or Light Level controllers offering single enclosure measurement and control solutions. Other features include maximum demand control for ventilation plants.



Model Type	Model	Description
	CDR	CDR Room CO ₂ and Temperature Sensor (Controller), 0..10Vdc Outputs
	CDRC	CDR Room CO ₂ and Temperature Sensor (Controller), 4..20mA Outputs
	-LCD	Display Option
	-DO	Digital Output Option (2DOs)
	-SP	Active Setpoint Option (for control loops) ^{Note 1}
	-SPR	Passive Setpoint Option (10kOhm potentiometer) ^{Note 1}
	-SPB	Active Setpoint Push Button Option ^{Note 3}
	-LL	Light Level Measurement and Occupancy Detection (with digital output) Option ^{Note 1}
	-PB	Push Button Interface Option (with digital output)
	-PB2	2 Momentary Push Buttons with Timer
	-TE-NTC10K3	Passive Temperature Sensor Option

Accessories	Model	Description
	SW-DCT-USB	Windows Device Configuration Tool Software with Serial USB Interface, 1.8m USB Lead

Note 1: If -SP/-SPR Option is selected the -LL options are no longer available (and vice versa).

Note 2: SP and SPR options cannot be fitted at the same time.

Note 3: Requires -LCD Option.

Order Codes

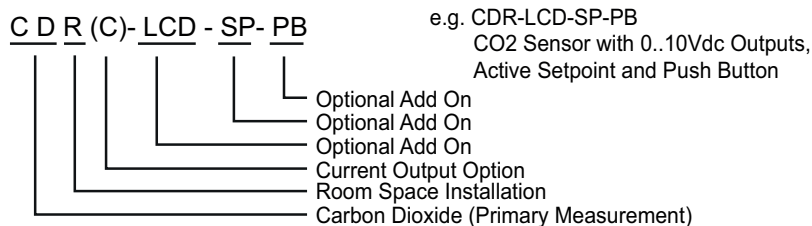

Technical Data

Power Supply	Power supply	24Vac/dc -10%/+15%, max 1VA
Displays and Interfaces	Option -LCD	LCD Display for Showing CO ₂ , Temperature, Light Level (configurable through the tool)
	Option -SP	Active Setpoint Potentiometer Knob (for control setpoint; adjustable min/max limits)
	Option -SPR	Passive Setpoint Knob (10kOhm potentiometer for external equipment)
	Option -SPB	Setpoint with 2 Push Buttons (network or control; adjustable min/max limits) <i>Note: Please select/order LCD option to visualise the setpoint. If this option is selected PB/PB2 options are replaced by setpoint buttons. If PB/PB2 are still required these are fitted underneath the SPB buttons (PB3/PB4 Binary Inputs)</i>
	Option -PB/-PB2	Push Button; status available through DO1 or DO2
Signal Outputs	CDR Transmitters	3 x 0..10Vdc < 5mA; 100k min impedance for 1% accuracy
	CDRC Transmitters	2 x 4..20mA max 250 Ohms
	Option - DO	2 x 24Vac Triacs; 2A maximum; requires 24Vac Power Supply (DO1 & DO2)
	Option -PB/-PB2	DO1 or DO2 configurable as 24Vac Triac; requires 24Vac Power Supply (PB option is supplied with DOs fitted)
	Option -LL	DO1 or DO2 configurable as 24Vac Triac; requires 24Vac Power Supply (LL option is supplied with DOs fitted)
	Option -SPR	0..10kOhm Resistance; Common 0V
	Option - TE-NTC10K3	NTC10K3 Thermistor; Common 0V
Sensing Characteristics	Carbon Dioxide (CO ₂)	
	Range	0..5000ppm CO ₂ (Range Adjustable)
	Accuracy	± 50ppm + 3% of the reading @ 25°C (@77°F)
	Technology	Auto Calibrating; Patented Non-Dispersive Infrared (NDIR)
	Non-Linearity	<1% FS
	Warm-Up Time	<20 seconds
	Response Time	2 minutes
	Temperature	
	Range	0..50°C (32..122°F)
	Accuracy	±0.3°C
	Occupancy; Option -LL	
	Occupancy	Infrared Detection (Adjustable Delay)
	Light Level; Option -LL	
Range	0..3,000 Lux	
Passive Temperature; Option -TE-NTC10K3 (Other elements available on request)		
Range	NTC10K3 Thermistor, 10kOhms @ 25°C	
Accuracy	±0.2°C	
Connections	Terminal Connections	Solid and Stranded Cable; 55° Angle for Wiring Maximum Size: 0.05 to 1.5mm ² (EN ISO) / 14 to 30 AWG (UL) Rising Clamp: Size 2.5 x 1.9mm
Environmental Conditions	Operating	
	Temperature	0°C...+50°C (32..122°F)
	Humidity	0..95%rh (non-cond.)
	Storage	
	Temperature	-30°C...+70°C (-22..158°F)

	Humidity	0...95%rh (non-cond.)
Standards	CE Conformity	CE Directive 2004/108/EY EN61000-6-3: 2001 (Generic Emission) EN61000-6-1: 2001 (Generic Immunity).
	Degree of Protection	IP20
Housing	Housing Material	ABS Plastics, Self Extinguishing, RAL9010 Pure White
	Mounting	Wall or Junction Box Mounting
	Dimensions	W86 x H120 x D29mm
	Weight	180g

Wiring Terminals

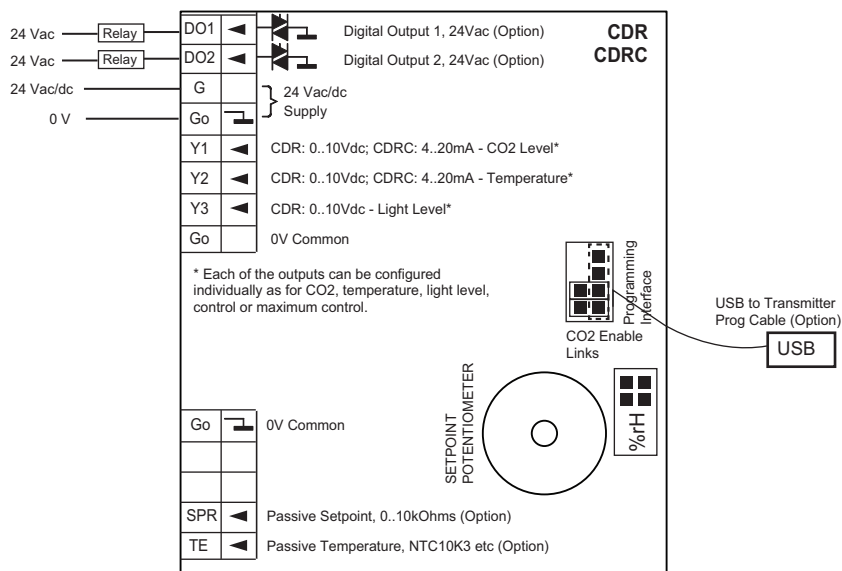

DO1	Digital Output; 24Vac Triac Switching to 0V; max. 2A (option, default Push Button status)
DO2	Digital Output; 24Vac Triac Switching to 0V; max. 2A (option, default Occupancy status)
G	24Vac/dc Power Supply
G0	0V Common
Y1	CDR: 0..10Vdc Analogue Output (Function Selectable, default CO2) CDRC: 4..20mA (Function Selectable, default CO2)
Y2	CDR: 0..10Vdc Analogue Output (Function Selectable, default temp) CDRC: 4..20mA (Function Selectable, default temp)
Y3	CDR: 0..10Vdc Analogue Output (Function Selectable, default LUX) CDRC: Not Available
G0	0V Common
G0	0V Common
N/A	Not applicable
N/A	Not applicable
SPR	Passive Setpoint, 0..10kOhms (option)
TE	Passive Temperature. NTC10K3 (option)

Wiring Precautions

Switch off the power before any wiring is carried out. If the sensor has the LCD display fitted, unplug the LCD display and then wire the power supply and analogue outputs, if relevant.

After the wiring has been completed; plug-in the display and power up the sensor.

Y1/Y2/Y3 Analogue Output Operation (Modes)

The analogue outputs Y1/Y2/Y3 can be configured for the following options.

Output Modes	Description
CO ₂ Measurement (Default for Y1)	The output represents the CO ₂ measurement. This is scaled over 0..10V (CDR) or 4..20mA (CDRC).
Temperature Measurement (Default for Y2)	The output represents the temperature measurement. This is scaled over 0..10V (CDR) or 4..20mA (CDRC).
Light Measurement	The output represents the light level measurement. This is scaled over 0..10V (CDR).
Temperature Control	The output represents the temperature control signal.
Light Control	The output represents the light level (LUX) control signal.
Maximum Control	The output represents the maximum of the CO ₂ and temperature control signals. Typically used in ventilation plants where the ventilation level is boosted based on high CO ₂ concentration or when high room temperature is prevailing (cooling).
Potentiometer (SP/SPB options)	Allows the setpoint potentiometer or push button setpoint position to be fed to the analogue output as 0..10V signal.
Max Hum/Temp	The output represents the maximum of the temperature and humidity control loops.
Max Hum/Temp/CO ₂	The output represents the maximum of the temperature, humidity and CO ₂ control loops.

Note: CDRC transmitters have only Y1 and Y2 outputs.

DO1/DO2 Digital Output (Options)

When DO1/DO2 digital output option is fitted (-DO option); this can be used to switch plants on/off based on a configured measurement and setpoint (thermostatic operation). If OC (Occupancy Sensor) option is fitted and then selected, the DO1/DO2 is used to switch output on when occupancy is detected. If the push button option (-PB) is fitted then DO1/DO2 can be set to switch ON when push button is pressed (delayed switch off).

Digital Output Mode Options	Description (Typical Operation)
Network	Not Applicable
CO ₂ Control Mode (e.g. CO ₂ High Limit Control)	Direct Mode: The DO1/DO2 is switched ON when the CO ₂ reading exceeds the CO ₂ Setpoint (1000 ppm default) + CO ₂ Digital Output Mode Hysteresis. The DO1/DO2 switches OFF when the CO ₂ reading drops below the setpoint. The control direction is adjustable; reverse / direct.
Temperature Control Mode (e.g. Low Temperature Limit)	Reverse Mode: The DO1/DO2 is switched ON when the temperature drops below the Temperature Setpoint - Temperature Mode Hysteresis. The output is switched OFF when the temperature exceeds the Setpoint. The control direction is adjustable; reverse (heating) / direct (cooling).
Light Level Control (LUX) Mode (e.g. Low Light Level) (requires -LL option)	Reverse Mode: The DO1/DO2 is switched ON when the light level drops below the Light Level Setpoint - Light Level Digital Output Mode Hysteresis, and switches OFF when the level increases above Setpoint. The control direction is adjustable.
Occupancy (requires -LL option)	The DO1/DO2 is switched ON when the occupancy sensor detects occupancy; the output remains on adjustable time "Occupancy Delay Time Setting" plus approx 10 seconds after occupancy has been detected.
Push Button 1 (requires -PB option)	If -PB option is fitted, it is possible to have the DO1 (or DO2) on for the "Push Button Delay Time" specified in the settings after the pressing of button is detected.
Push Button 2	If -PB2 option is fitted then option for Push Button 2 is also available.

CO2 Measurement Output Scaling and Single Point Calibration

The CDR measures the carbon dioxide content of the room space and the measurement can be sent to any of the analogue outputs (Y1/Y2/Y3 for CDR, and Y1/Y2 for CDRC).

This output is scaled as default 0% = 0ppm and 100% = 2,000ppm. The scaling can be modified through the Maximum CO2 Scaling parameter.

Furthermore the CO2 measurement reading can be adjusted on site using the Single Point Calibration field.

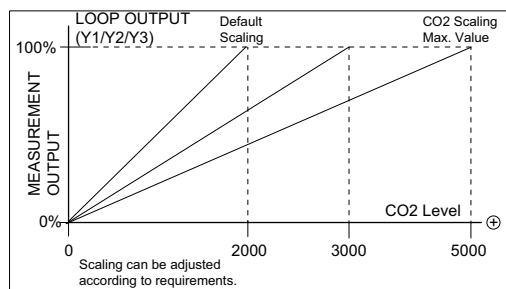

CO2 Measurement Enable

CO2 measurement is enabled by inserting CO2 link jumpers (two) on the programming header. As default these are fitted (see programming interface section for further details).

CO2 Measurement Auto-Calibration

The CO2 sensor has automatic auto-calibration feature. This feature monitors the background CO2 level over the calibration period (8 days), and calibrates the CO2 level to the lowest point measured during this period. The sensors are supplied as factory calibrated to the typical background levels. After powering up the sensor, the sensor carries out initial calibration within 1 day after which the CO2 level is calibrated every 8 days automatically. The auto calibration logic virtually eliminates the need for manual calibration in applications where the indoor CO2 drops to outside levels during unoccupied periods.

NOTE: If the CO2 sensor is fitted in spaces where the background level does not drop close to the typical background level (= fresh air) of 400ppm (e.g. greenhouses) it is essential that the auto-calibration feature is disabled during the commissioning.

Temperature Measurement Output Scaling and Single Point Calibration

The CDR measures the room space temperature, and the measurement can be sent to any of the analogue outputs (Y1/Y2/Y3 for CDR, and Y1/Y2 for CDRC).

This output is scaled as default 0% = 0°C and 100% = 50°C. The scaling can be modified through the Maximum Temperature Scaling parameter. The output can also be scaled in Fahrenheit units.

Furthermore the temperature measurement reading can be adjusted on site using the Single Point Calibration field.

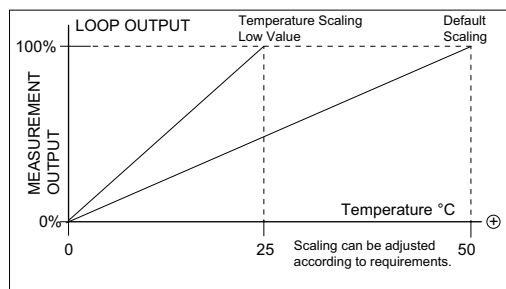

Light Level Measurement Output Scaling; Only when -LL Option Fitted

The CDR sensors fitted with -LL option measure the light level. The light level (LUX) measurement is available over any of the analogue outputs (Y1/Y2/Y3 for CDR, and Y1/Y2 for CDRC)

This output is scaled as default 0% = 0 LUX and 100% = 3,000 LUX. The scaling can be modified through the Maximum LUX Scaling parameter.

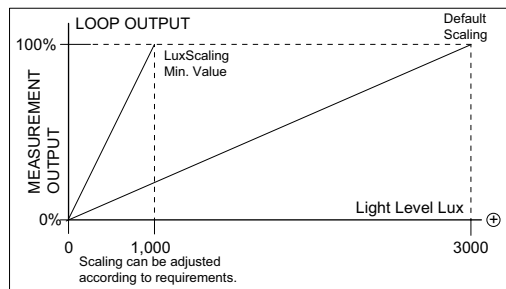

Occupancy Sensor (-LL Option)

The LL option offers a low power Passive Infrared Motion sensor with 21mm Fresnel lens designed for HVAC ventilation and lighting control applications. The sensor detects human body within its detection range. The LL sensor employs a dual element pyroelectric infrared sensor with advanced electronics circuitry.

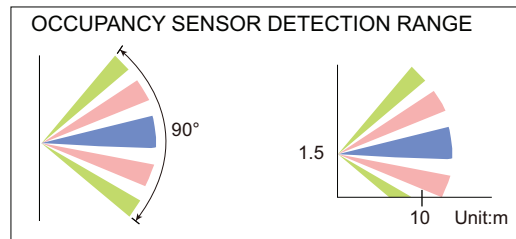

CO2 Control Loop Operation Proportional or PI Control (Reverse/ Direct)

The CO2 measurement can be used for the CO2 control. The calculated control demand is then send to the output Y1, Y2 or Y3 (depending on the corresponding analogue output mode selection).

The CO2 control loop output corresponds to the CO2 setpoint and CO2 proportional band. If configured as Direct Control (typical), then if the CO2 level increases above the setpoint the loop output starts to modulate to 100%. When the CO2 level is the amount of the Proportional Band above the setpoint the loop output is 100%. The configuration is done via the configuration parameters. The CO2 control loop can also be configured to operate as Proportional + Integral control by changing the Integral Action Time from 0 to a required value.

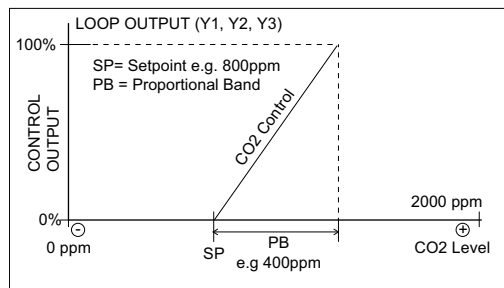

Boost Function

It is possible to boost/override the control output to 100%. This can be achieved via a push button on the device (PB-option). If the Push Button is used then the control output is boosted to 100% for the amount of Push Button Delay Time. When the boost is active the Blue Push Button backlight is lit. The boost can be cancelled by pressing the push button again.

CO2 Measurement Enable

CO2 measurement is enabled by inserting CO2 link jumpers (two) on the programming header. As default these are fitted (see programming interface section for further details).

CO2 Measurement Auto-Calibration

The CO2 sensor has automatic auto-calibration feature. This feature monitors the background CO2 level over the calibration period (8 days), and calibrates the CO2 level to the lowest point measured during this period. The sensors are supplied as factory calibrated to the typical background levels. After powering up the sensor, the sensor carries out initial calibration within 1 day after which the CO2 level is calibrated every 8 days automatically. The auto calibration logic virtually eliminates the need for manual calibration in applications where the indoor CO2 drops to outside levels during unoccupied periods.

NOTE: If the CO2 sensor is fitted in spaces where the background level does not drop close to the typical background level (= fresh air) of 400ppm (e.g. greenhouses) it is essential that the auto-calibration feature is disabled during the commissioning.

Temperature Control Loop Operation

Proportional or PI Control (Reverse/ Direct)

The temperature measurement can also be used for the temperature control. The calculated control demand is then send to the output Y1, Y2 or Y3 (depending on the corresponding analogue output mode selection).

The temperature control loop output corresponds to the temperature setpoint and the temperature proportional band. If configured as Reverse Control (heating), then if the temperature level drops below the setpoint the loop output starts to modulate to 100%. When the temperature is the amount of the Proportional Band below the setpoint the loop output is 100%. In the Direct Control mode the output modulates in reverse. The configuration is done via the configuration parameters.

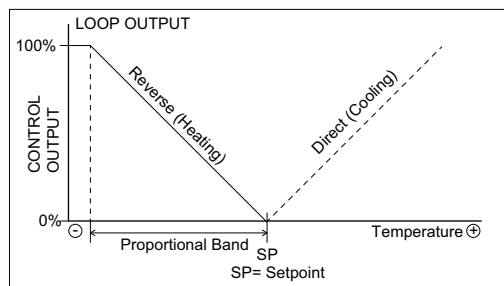

The temperature control loop can also be configured to operate as Proportional + Integral control by changing the Integral Action Time from 0 to a required value.

Boost Function

It is possible to boost/override the control output to 100%. This can be achieved via a push button on the device (PB-option). If the Push Button is used then the control output is boosted to 100% for the amount of Push Button Delay Time. When the boost is active the Blue Push Button backlight is lit. The boost can be cancelled by pressing the push button again.

Light Level (LUX) Control Loop Operation; Only when -LL Option Fitted

Proportional Control (Reverse/ Direct)

The LUX measurement can also be used for the light control. The calculated control demand is sent to the output Y1, Y2 or Y3 (depending on the corresponding analogue output mode selection).

The light control loop output corresponds to the light level setpoint and the light control proportional band. If configured as Reverse Control, then if the light level drops below the setpoint the loop output starts to modulate to 100%. When the light level is the amount of the Proportional Band below the setpoint the loop output is 100%. In the Direct Control mode the output modulates in reverse. The configuration is done via the configuration parameters.

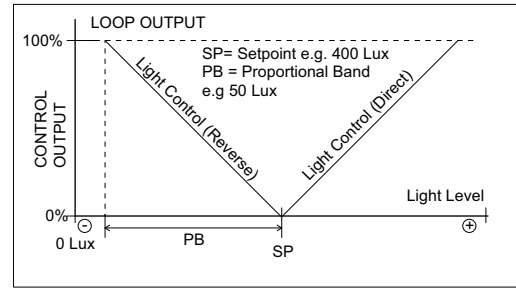

The LUX control loop can also be configured to operate as Proportional + Integral control by changing the Integral Action Time from 0 to a required value.

Boost Function

It is possible to boost/override the control output to 100%. This can be achieved via a push button on the device (PB-option). If the Push Button is used then the control output is boosted to 100% for the amount of Push Button Delay Time. When the boost is active the Blue Push Button backlight is lit. The boost can be cancelled by pressing the push button again.

Unoccupied Setpoint

If the sensor has been configured for control, then it is possible to set the control setpoint to a different setting during the unoccupied periods (controlled by the occupancy sensor). Great feature for energy savings.

Maximum Control Loops

Each of the analogue outputs can also be configured as "Maximum Control". In this case the corresponding output (Y1, Y2, Y3) takes the maximum of the CO2 Loop and Temperature Loop outputs. This is typically used in demand based ventilation.

Furthermore the each analogue output can be configured as "Max Hum/Temp" or "Max Hum/Temp/CO2", in which case the maximum of these control loops is taken.

Digital Output DO1/DO2 Control Modes (Optional)

When the digital outputs DO1 and DO2 are fitted they can be configured to work in any of the control modes; CO2 Control, Temperature Control or LUX control; the corresponding digital output is switched ON/OFF based on the corresponding Setpoint property and the corresponding hysteresis. The direction of the operation is also adjustable through Control Loop Operating Mode Parameter.

The diagram below illustrates the operation for Temperature Control Mode. The same concept is applicable for any of the DO1/DO2 control modes (CO2, Temperature, LUX).

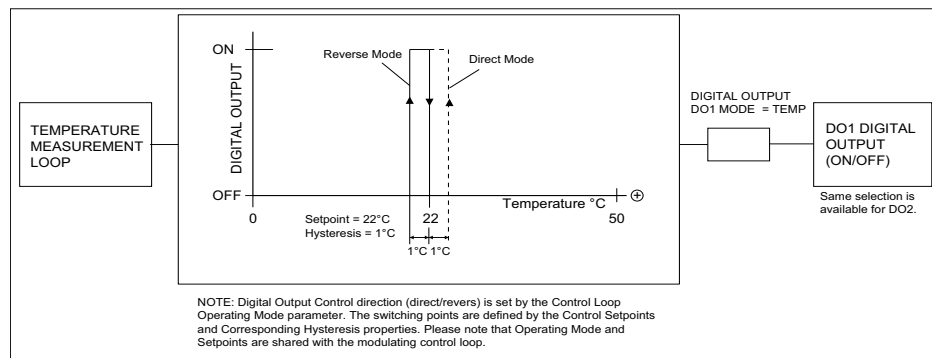

Active Setpoint Potentiometer (-SP option) Setpoint with Push Buttons (-SPB option)

With setpoint options it is possible to adjust the current control setpoint. The setpoint potentiometer (knob) option provides rotary knob for the setpoint whereas the SPB option provides two push buttons for setpoint. The adjustment shifts the CO₂, temperature, humidity or LUX setpoint up or down depending on the configuration parameter settings.

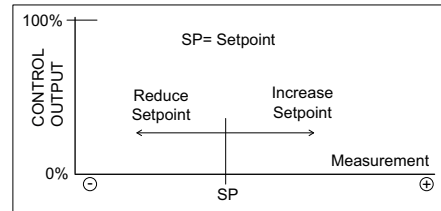

Note: SPB option requires also -LCD option to be selected/fitted.

It is also possible to send the setpoint potentiometer position (-SP option) or Setpoint Push Button Setting (-SPB option) to an analogue output as 0..10V signal.

Boost Function / Push Buttons

It is possible to boost/override any of the control outputs to 100%. This can be achieved via a push button on the device (PB/PB2-options). If the Push Button is used then the control output is boosted to 100% for the amount of Push Button Delay Time. When the boost is active the Blue Push Button backlight is lit. The boost can be cancelled by pressing the push button again.

Note: It is possible to print the push button caps with custom legends. Please contact SyxtSense Sales for further details.

Display (Requires Option -LCD)

The LCD display shows the temperature, CO₂ and LUX readings. The CO₂, temperature and LUX readings are primary readings displayed on the "top line". These readings can be rotated. The display has white backlight which is as default switched off. The backlight can be switched permanently on and its intensity can be adjusted.

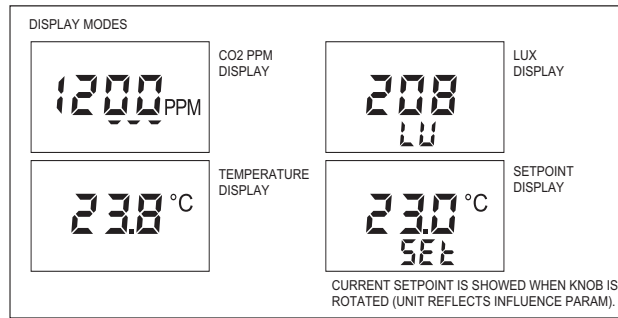

Note: The backlight is permanently on if activated. At 50% intensity the backlight lifetime is approx 10,000 hours. After this time the LCD module needs replacing if backlight is required. The display continues to operate without backlight.

Configuration Parameters and Programming

The parameter options can be configured using the DCT Device Configuration Tool software. The DCT Configuration software is connected via the PC USB cable (or via Bluetooth module) to the programming header of the transmitter. In order to connect please remove temporarily the CO₂ link jumpers (two), and store them securely to re-fit them after the programming is complete. Then plug-in the USB cable to the programming header as shown on the image below.

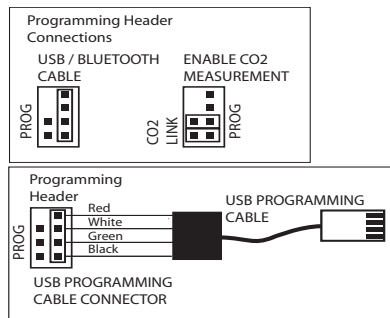

The correct process for connecting the sensor via the USB is as follows:-

- Disconnect USB Connector from PC
- Disconnect the Sensor from Power
- Plug-In the 4-Way Connector to the Sensor
- Connect the USB to the PC
- Power Up the Sensor

NOTE: Always disconnect USB from PC before plugging the cable into the sensor.

NOTE: The CO₂ readings are not available unless the CO₂ link jumpers are fitted.

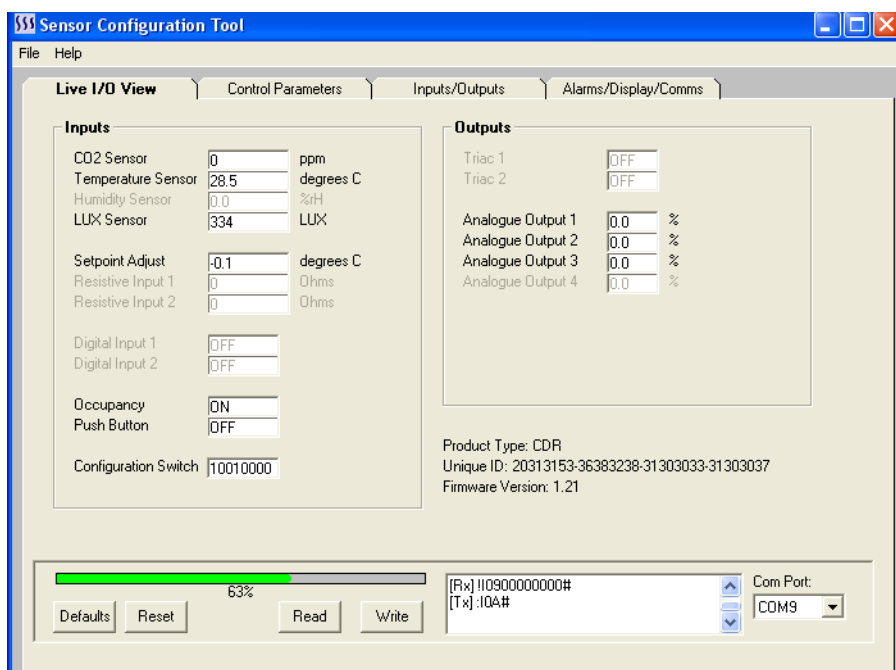

Common Parameters	
Parameter Name	Description
Defaults	Reloads the default configuration from the sensor non-volatile memory. Note: All modified settings are lost.
Reset	Performs soft reset of the sensor. Apply after major changes.
Read	Reads the sensor data.
Write	Writes the new settings to the sensor (automatically stored in the non-volatile memory)
COM Port	Select the COM port for the USB Cable or Bluetooth. USB cable driver must be installed in order the Serial to TTL connection to operate.

Live IO-View		
Parameter Name	Description	Range
INPUTS		
CO2 Sensor	CO2 Sensor Reading	0..5,000ppm
Temperature Sensor	Temperature Sensor Reading	0..50°C (32..122°F)
Humidity Sensor	Humidity Sensor Reading	Not Applicable
LUX Sensor	LUX Sensor Reading	0..3,000 LUX
Setpoint Adjust	Setpoint Adjuster Reading	-500..+500
Resistive Input 1	Not applicable	Not applicable
Resistive Input 2	Not applicable	Not applicable
Digital Input 1	Not applicable	Not applicable
Digital Input 2	Not applicable	Not applicable
Occupancy	Occupancy Status	Off - On
Push Button	Push Button Status	Off - On
Configuration Switch	Bit Switch Status for Each Switch	00000000 - 11111111
OUTPUTS		
Triac 1	Digital Output 1	Off - On
Triac 2	Digital Output 2	Off - On
Analogue Output 1	Analogue Output 1	0..100%
Analogue Output 2	Analogue Output 2	0..100%
Analogue Output 3	Analogue Output 3	0..100%

Control Parameters		
Parameter Name	Description	Range
TEMPERATURE		
Temperature Loop Operating Mode	Direction of the temperature control loop.	0 = Reverse Control (Heating) 1 = Direct Control (Cooling)
Temperature Control Setpoint	Temperature Setpoint	0.0...150.0°C/°F (Default 20°C)
Temperature Proportional Band	Temperature Proportional Band	1.0...150.0°C/°F (Default 50°C)
Temperature Control Integral Action	Integral Action time of the temperature control loop. Set to 0 to disable.	0..10,000 seconds (Default 0)
Temperature Digital Output Mode Hysteresis	Hysteresis for the digital output temperature control function.	0.1...150.0°C/°F (Default 2°C)
Temperature Loop Boost Input	Boosts the Control Output to 100%	Select Push Button 1 or 2
HUMIDITY - Not Applicable		
CO2		
CO2 Loop Operating Mode	Direction of the CO2 control loop.	0 = Reverse Control 1 = Direct Control
CO2 Control Setpoint	CO2 Setpoint	0..3250ppm (Default 1,000 ppm)
CO2 Proportional Band	CO2 Proportional Band	10..5000 ppm (Default = 300 ppm)
CO2 Control Integral Action	Integral Action time of the CO2 control loop. Set to 0 to disable.	0..10,000 seconds (Default 0)
CO2 Digital Output Mode Hysteresis	Hysteresis for the digital output CO2 control function.	10..5000ppm (Default 100 ppm)
CO2 Loop Boost Input	Boosts the Control Output to 100%	Select Push Button 1 or 2
LUX		
Lux Loop Operating Mode	Direction of the LUX control loop.	0 = Reverse Control 1 = Direct Control
Lux Control Setpoint	LUX Setpoint	0..3,000 Lux (Default 400 Lux)
LUX Proportional Band	LUX Proportional Band	1..3,000 Lux (Default 400 Lux)
LUX Control Integral Action	Integral Action time of the LUX control loop. Set to 0 to disable.	0..10,000 seconds (Default 0)
LUX Digital Output Mode Hysteresis	Hysteresis for the digital output LUX control function.	1..3,000 Lux (Default 100 Lux)
LUX Loop Boost Input	Boosts the Control Output to 100%	Select Push Button 1 or 2
SETPOINT ADJUST		
Setpoint Adjuster Minimum Value	Sets the minimum value for the setpoint (setpoint turned fully anti clockwise)	-500..0 (Default -3.0)
Setpoint Adjuster Maximum Value	Sets the maximum value for the setpoint (setpoint turned fully clockwise)	0..500 (Default 3.0)
Setpoint Value Influence to Control Setpoint	Setpoint Value Influence to Control Setpoint	0 = No Influence 1 = CO2 Control 2 = Temperature 3 = Humidity (not applicable) 4 = Lux
Unoccupied SPA	Changes the control setpoint to the set value when the space is unoccupied (requires -LL option)	0..500 (Default 0.0)

Inputs / Outputs		
Parameter Name	Description	Range
SENSOR INPUTS		
CO2 Offset	One Point CO2 Calibration Field	-200..+200ppm (Default 0ppm)
CO2 AO Scale	Analogue Output Maximum CO2 Scaling	1000..5000 ppm (Default = 2,000 ppm)
Temperature Offset	One Point Temperature Calibration Field	-3.0..+3.0°C/°K (Default 0°C)
Temperature AO Scale	Analogue Output Maximum Temperature Scaling	0.1...150.0°C/°F (Default 50°C)
Humidity Offset	Not Applicable	
Humidity AO Scale	Not Applicable	

Inputs / Outputs		
Parameter Name	Description	Range
LUX AO Scale	Analogue Output Maximum Lux Scaling	1000..3,000 Lux (Default 3,000 Lux)
Occupancy Off Delay	Delay Time Setting for Occupancy	1..7200 Seconds (Default 600)
Push Button Off Delay	Delay Time Setting for Push Button	1..7200 Seconds (Default 600)
DI1 Off Delay	Not applicable	Not applicable
DI2 Off Delay	Not applicable	Not applicable

OUTPUTS

AO1 (Y1)	Analogue Output Y1 Mode Default: 1 = CO2 Sensor	0 = Network Value (N/A) 1 = CO2 Measurement 2 = Temperature Measurement 3 = Humidity Measurement (N/A) 4 = Light Measurement (LUX) 5 = CO2 Control 6 = Temperature Control 7 = Humidity Control 8 = Light Control (LUX) 9 = Maximum Control 10 = Potentiometer 11 = Max Hum/Temp Control 12 = Max Hum/Temp/CO2 Control
AO2 (Y2)	Analogue Output Y2 Mode Default 2 = Temperature Sensor	
AO3 (Y3) Note: Not available with CDRC.	Analogue Output Y3 Mode Default: 3 = Humidity Sensor	
DO1	Digital Output 1 Mode Default: 6 = Push Button 1	0 = Network Value ((N/A) 1 = CO2 Control 2 = Temperature Control 3 = Humidity Control (N/A) 4 = Light Control (LUX) 5 = Occupancy 6 = Push Button 1 7 = Push Button 2 8-11 = Not Applicable
DO2	Digital Output 2 Mode Default: 5 = Occupancy	

Alarm/Display/Comms		
Parameter Name	Description	Range
DISPLAY		
Temperature Units	Temperature Unit Selection	0 = Celsius 1 = Fahrenheit
Language	Language Selection (for display rH vs FH)	Not Applicable
Display Mode	Display Mode	0 = Rotate Installed 1 = CO2 Only 2 = Temperature Only 3 = LUX Only 4 = Setpoint Only
LCD brightness	Brightness of the LCD	Off - 10% to 100%

ALARM (not applicable)**COMMS (not applicable)****Parameter Storage**

The configuration parameters are stored in the non-volatile memory. The DCT (Device Configuration Tool) software will automatically store the register values on the non-volatile permanent memory after the changes are carried out.

Dimensions

