

» WRF04 (x) (LCD) RS485 Modbus

Room temperature sensor/ Room operating unit/ Room controller

thermokon[®]
HOME OF SENSOR TECHNOLOGY

Datasheet

Subject to technical alteration
Issue date: 09.07.2019 • A100



Illustration similar, depending on the type

» APPLICATION

The surface-mounted room controller is used for individual temperature control in living, hotel and office rooms. Possible operating elements are potentiometers, rotary switches, buttons and LEDs for setpoint adjustment, fan level selection, presence detection and visual feedback. Depending on the type, continuous or 2-point valves can be controlled for heating or cooling. The connection terminal in the lower housing part allows pre-wiring.

» TYPES AVAILABLE

Room controller temperature optional with LCD – active BUS

WRF04 (x) (LCD) AO2V RS485 Modbus

Room controller/ operating unit temperature optional with LCD – active BUS with flush mounted IO module

WRF04 (x) (LCD) DO2R RS485 Modbus
WRF04 (x) (LCD) DO2T RS485 Modbus
WRF04 (x) (LCD) OVR RS485 Modbus
WRF04 (x) (LCD) OVT RS485 Modbus

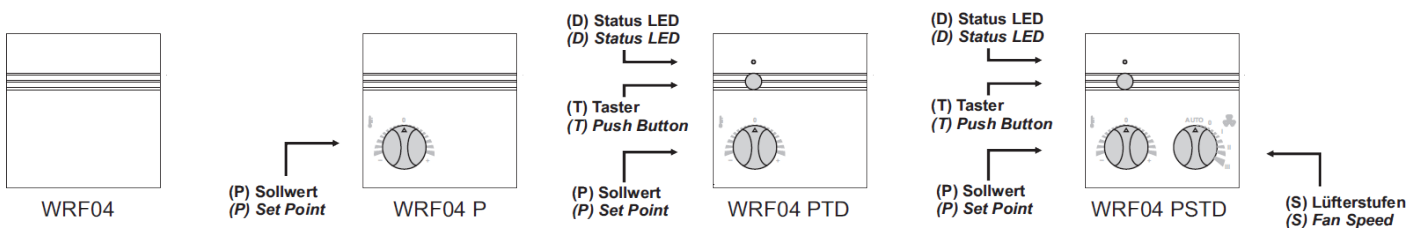

optional operating elements

P = Potentiometer – Set point adjustment

T = Button – Occupancy

S = Rocker switch – Fan speed adjustment

FSx = Number of switching stages

» SECURITY ADVICE – CAUTION



The installation and assembly of electrical equipment should only be performed by authorized personnel.

The product should only be used for the intended application. Unauthorised modifications are prohibited! The product must not be used in relation with any equipment that in case of a failure may threaten, directly or indirectly, human health or life or result in danger to human beings, animals or assets. Ensure all power is disconnected before installing. Do not connect to live/operating equipment.

Please comply with

- Local laws, health & safety regulations, technical standards and regulations
- Condition of the device at the time of installation, to ensure safe installation
- This data sheet and installation manual

» NOTES ON DISPOSAL



As a component of a large-scale fixed installation, Thermokon products are intended to be used permanently as part of a building or a structure at a pre-defined and dedicated location, hence the Waste Electrical and Electronic Act (WEEE) is not applicable. However, most of the products may contain valuable materials that should be recycled and not disposed of as domestic waste. Please note the relevant regulations for local disposal.

» REMARKS TO ROOM SENSORS

Location and Accuracy of Room Sensors

The room sensor should be mounted in a suitable location for measuring accurate room temperature. The accuracy of the temperature measurement also depends directly on the temperature dynamics of the wall. It is important, that the back plate is completely flush to the wall so that there is sufficient circulation of air through the vents in the cover, otherwise, deviations in temperature measurement will occur due to uncontrolled air circulation. The temperature sensor should not be covered by furniture or other objects. Mounting next to doors (due to draught) or windows (due to colder outside wall) should be avoided.

Surface and Flush Mounting

The measuring result is influenced by the thermal characteristics of the wall. A solid concrete wall responds to thermal fluctuations within a room in a much slower than a light-weight structure wall. Room temperature sensors installed in flush-mounted boxes have a longer response time to thermal variations. In extreme cases they detect the radiant heat of the wall even if the air temperature in the room is lower for example. The quicker the dynamics of the wall (temperature acceptance of the wall) or the longer the selected inquiry interval of the temperature sensor is the smaller the deviations limited in time are.

» BUILD-UP OF SELF-HEATING BY ELECTRICAL DISSIPATIVE POWER

Temperature sensors with electronic components always have a dissipative power, which affects the temperature measurement of the ambient air. The dissipation in active temperature sensors shows a linear increase with rising operating voltage. This dissipative power has to be considered when measuring temperature. In case of a fixed operating voltage ($\pm 0,2$ V) this is normally done by adding or reducing a constant offset value. As Thermokon transducers work with a variable operating voltage, only one operating voltage can be taken into consideration, for reasons of production engineering. Transducers 0..10 V / 4..20 mA have a standard setting at an operating voltage of 24 V =. That means, that at this voltage, the expected measuring error of the output signal will be the least. For other operating voltages, the offset error will be increased or lowered by a changing power loss of the sensor electronics. If a re-calibration should become necessary later directly on the sensor, this can be done by means of a trimming potentiometer on the sensor board.

Remark: Occurring draft leads to a better carrying-off of dissipative power at the sensor. Thus temporally limited fluctuations might occur upon temperature measurement.

» PRODUCT TESTING AND CERTIFICATION



Declaration of conformity

The declaration of conformity of the products can be found on our website <https://www.thermokon.de/>.

» TECHNICAL DATA

Measuring values	temperature	
Output voltage (type-dependent)	AO2V 2x 0..10 V, heating & cooling or 6-way-valve (min. load 10 kΩ)	
Output switching contact (type-dependent)	DO2R OVR (Relay) switching contact 24 V / 3 A, floating	DO2T OVT (Triac) 24 V ~ / 1 A, floating
Network technology	RS485 Modbus, RTU or ASCII, half-duplex, baud rate 9.600, 19.200, 38.400 or 57.600, parity: non (2 stopbits), even or odd (1 stopbit)	
Power supply	15..24 V = (±10%) or 24 V ~ (±10%) SELV	
Power consumption	typ. 0,4 W (24 V =) 0,6 VA (24 V ~)	
Measuring range temperature	0..+50 °C	
Accuracy temperature	±0,5 K (typ. at 21 °C)	
Inputs	2 inputs for floating contacts	
Set point (P) (optional)	set point adjustment	
Rotary switch (S) (optional)	setpoint adjustment (max. 5 stages), 2-stages (0,I), 3-stages (0,I,II), 4-stages (0,I,II,III) or 5-stages (Auto,0, I, II, III)	
Button (T) (optional)	presence detection	
LED (D) (optional)	status feedback, more LEDs available, colour green, red or yellow	
Functions	with integrated PI controller	
Labelling	rotary switch 0,I or 0,I,II or 0,I,II,III or Auto,0,I,II,III	set point -,0,+
Display (optional)	LCD 29x12 mm, monochrome	
Enclosure	PC, pure white	
Protection	IP30 according to EN 60529	
Cable entry	breaking points top/bottom, rear entry	
Connection electrical	Terminal block, max. 1,5 mm ²	
Ambient condition	-35..+70 °C, max. 85% rH non-condensing	
Mounting	surface mounted on flush-mounting box (Ø=60 mm), or to be mounted flat onto the surface using screws, with frame for surface mounting (accessory) or directly on the wall, base part can be mounted and wired separately	
Notes	special painting available on request, enclosure stainless steel available, labelling and operating elements on request, other sensors on request	

IO-Modul

Power consumption (with IO module)	typ. 0,7 W (24 V =) 1 VA (24 V ~)
Enclosure	ABS, black
Protection	IP00 according to EN 60529
Weight	80 g

» MOUNTING ADVICES

Make sure that the device is power-off, if you install it!

The device can be installed on a smooth wall surface or a flush box. It should be selected a representative location for the measuring medias. The use of deep installation boxes is recommended due to the increased storage capacity for the cabling.

Sunlight and drafts e.g. in conduit must be avoided so that the measuring result is not distorted. If necessary, is the end of the installation tube seal

(1) For wiring, the upper part of the base plate must be solved. Base plate and upper part are connected with each other by mounting clips.

(2) The installation of the base plate to the smooth wall surface can be done with plugs and screws.

(3) Then, the device is placed on the base plate.

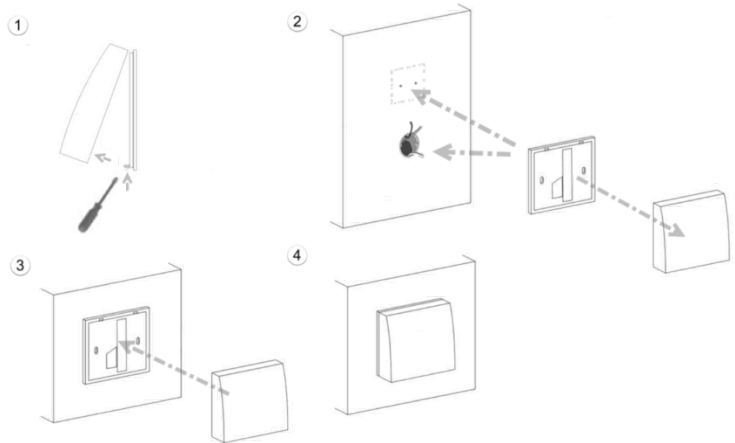

» CONNECTION PLAN

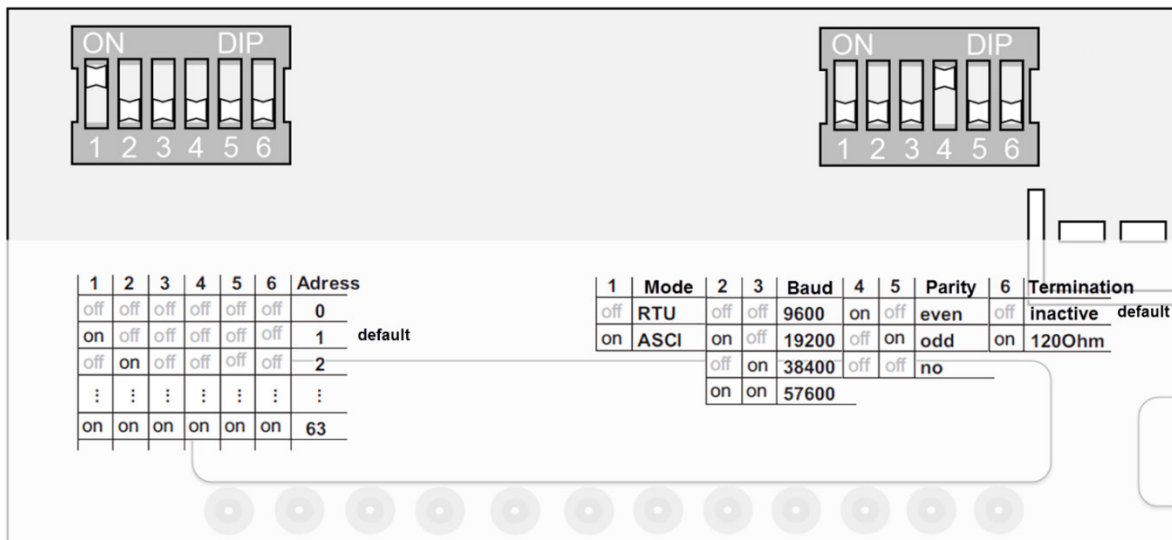

WRF04 (x) (LCD)AO2V

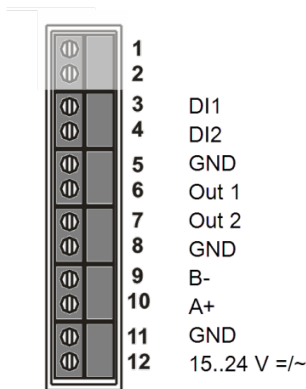

with IO-module (optional)

The Modbus connection is performed on the mainboard

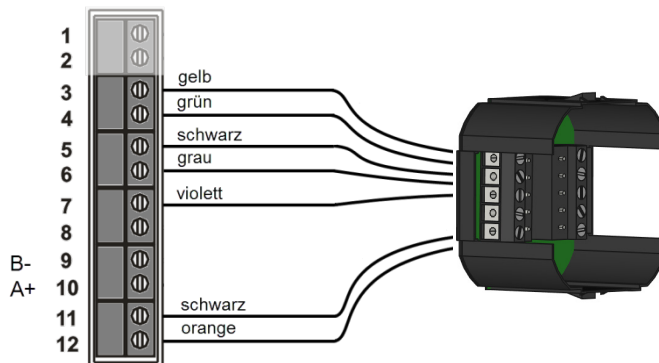

WRF04 (x) (LCD)

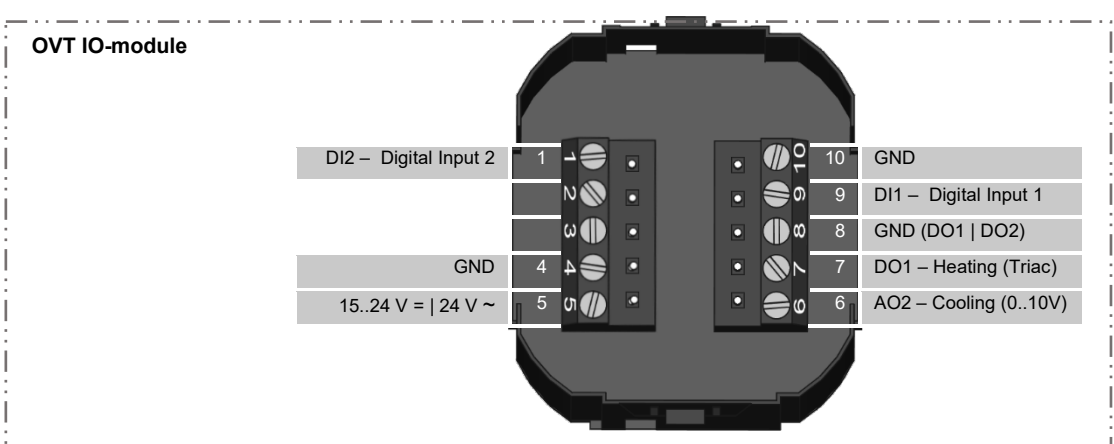
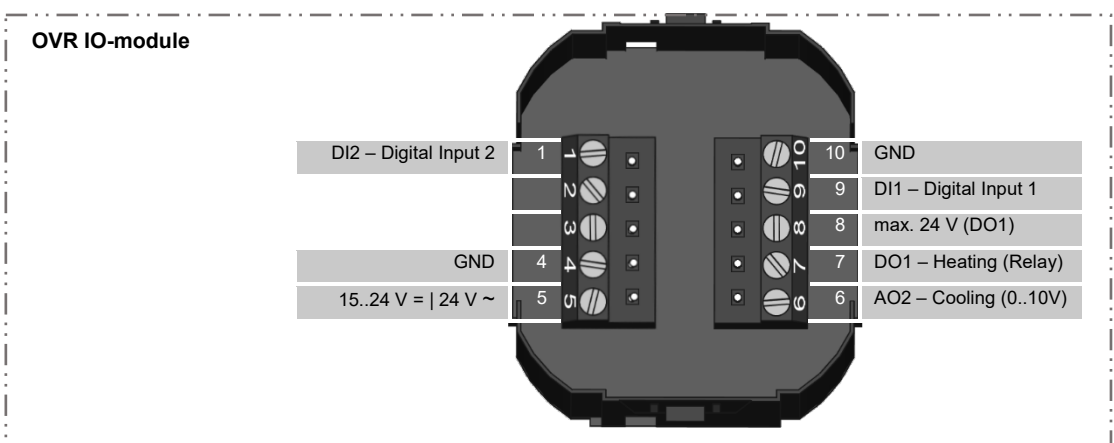
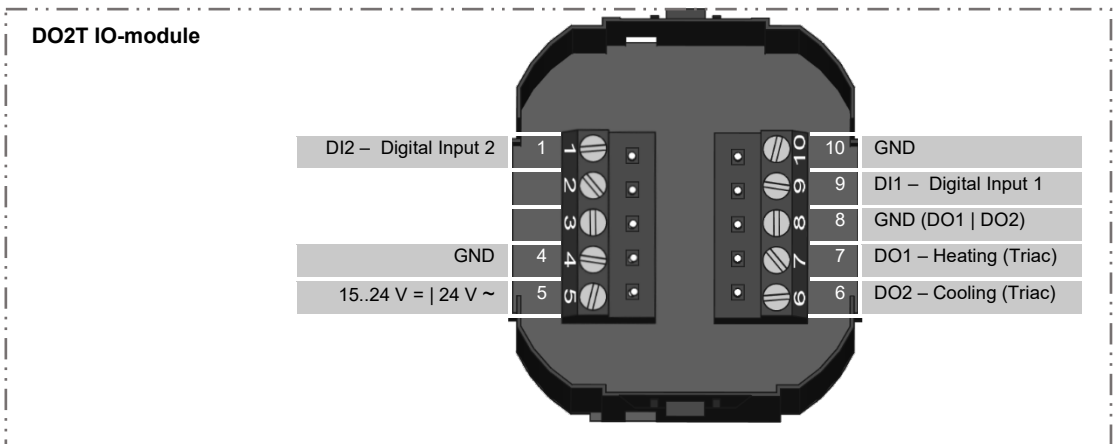
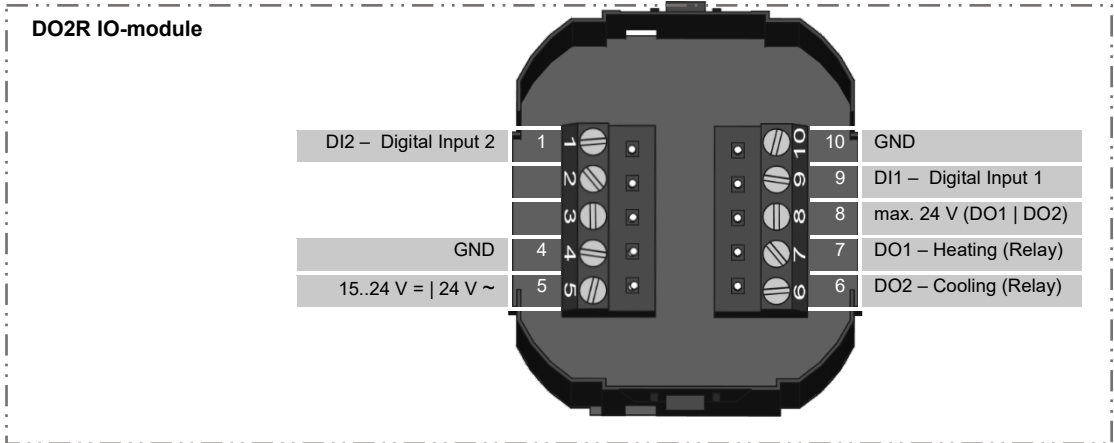

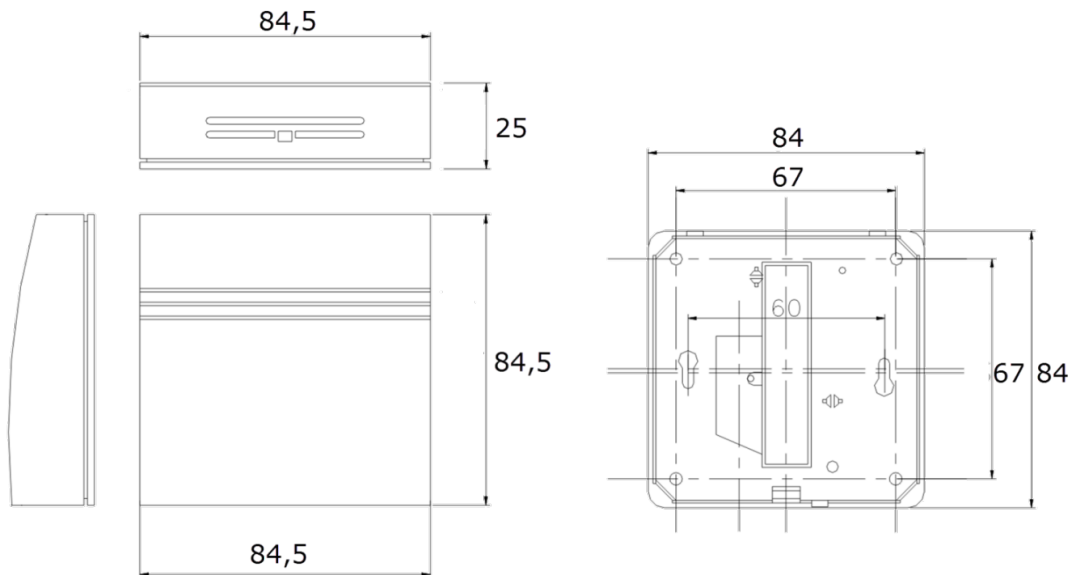
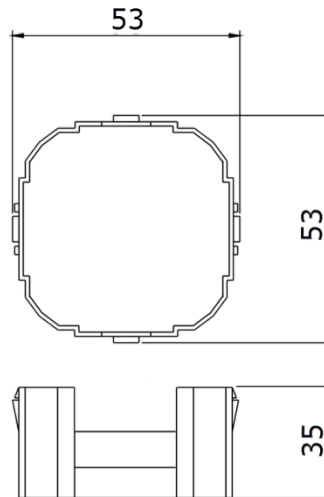
» **DIMENSIONS (MM)**» **IO-extension (IO module)**» **ACCESSORIES (OPTIONAL)**

Rawl plugs and screws (2 pcs. each)
 Frame for surface mounting WRF04
 Balls stroke protection BS100 (only for WRF04)

Item No. 102209
 Item No. 111584
 Item No. 103312